

Using Neural Networks for Bug Localization

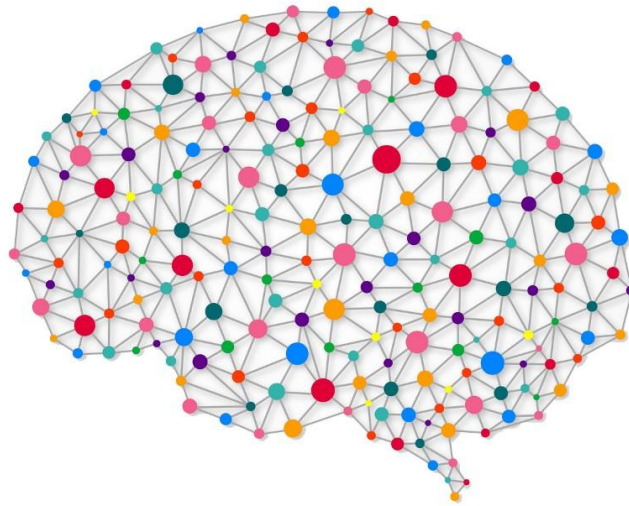

Sébastien Broggi

Bachelor thesis

25.02.2017

How can we identify buggy methods?

```
void init(View decor){
    mContext = decor.getContext();
    mActionView = (ActionBarView) decor.findViewById(R.id.abs__action_bar);
    mContextView = (ActionBarContextView) decor.findViewById(R.id.abs__action_context_bar);
    mContainerView = (ActionBarContainer) decor.findViewById(R.id.abs__action_bar_container);
    mSplitView = (ActionBarContainer) decor.findViewById(R.id.abs__split_action_bar);
    if (mActionView == null || mContextView == null || mContainerView == null) {
        throw new IllegalStateException(getClass().getSimpleName() + " can only be used " + "with a compatible window decor layout");
    }
    mActionView.setContextView(mContextView);
    mContextDisplayMode = mActionView.isSplitActionBar() ? CONTEXT_DISPLAY_SPLIT : CONTEXT_DISPLAY_NORMAL;
    boolean homeButtonEnabled = mContext.getApplicationInfo().targetSdkVersion < Build.VERSION_CODES.ICE_CREAM_SANDWICH;
    homeButtonEnabled |= (mActionView.getDisplayOptions() & ActionBar.DISPLAY_HOME_AS_UP) != 0;
    setHomeButtonEnabled(homeButtonEnabled);
    setHasEmbeddedTabs(getResources_getBoolean(mContext, R.bool.abs__action_bar_embed_tabs));
}
```

Ground truth

Bug:

```
void init(View decor){
    mContext = decor.getContext();
    mActionBarView = (ActionBarView) decor.findViewById(R.id.abs__action_bar);
    mContextView = (ActionBarContextView) decor.findViewById(R.id.abs__action_context_bar);
    mContainerView = (ActionBarContainer) decor.findViewById(R.id.abs__action_bar_container);
    mSplitView = (ActionBarContainer) decor.findViewById(R.id.abs__split_action_bar);
    if (mActionBarView == null || mContextView == null || mContainerView == null) {
        throw new IllegalStateException(getClass().getSimpleName() + " can only be used " + "with a compatible window decor layout");
    }
    mActionBarView.setContextView(mContextView);
    mContextDisplayMode = mActionBarView.isSplitActionBar() ? CONTEXT_DISPLAY_SPLIT : CONTEXT_DISPLAY_NORMAL;
    setHomeButtonEnabled(mContext.getApplicationInfo().targetSdkVersion < 14);
}

setHasEmbeddedTabs(getResources_getBoolean(mContext, R.bool.abs__action_bar_embed_tabs));
}
```

Fixed:

```
void init(View decor){
    mContext = decor.getContext();
    mActionBarView = (ActionBarView) decor.findViewById(R.id.abs__action_bar);
    mContextView = (ActionBarContextView) decor.findViewById(R.id.abs__action_context_bar);
    mContainerView = (ActionBarContainer) decor.findViewById(R.id.abs__action_bar_container);
    mSplitView = (ActionBarContainer) decor.findViewById(R.id.abs__split_action_bar);
    if (mActionBarView == null || mContextView == null || mContainerView == null) {
        throw new IllegalStateException(getClass().getSimpleName() + " can only be used " + "with a compatible window decor layout");
    }
    mActionBarView.setContextView(mContextView);
    mContextDisplayMode = mActionBarView.isSplitActionBar() ? CONTEXT_DISPLAY_SPLIT : CONTEXT_DISPLAY_NORMAL;
    boolean homeButtonEnabled = mContext.getApplicationInfo().targetSdkVersion < Build.VERSION_CODES.ICE_CREAM_SANDWICH;
    homeButtonEnabled |= (mActionBarView.getDisplayOptions() & ActionBar.DISPLAY_HOME_AS_UP) != 0;
    setHomeButtonEnabled(homeButtonEnabled);
    setHasEmbeddedTabs(getResources_getBoolean(mContext, R.bool.abs__action_bar_embed_tabs));
}
```

Word2Vec to learn similarities of words

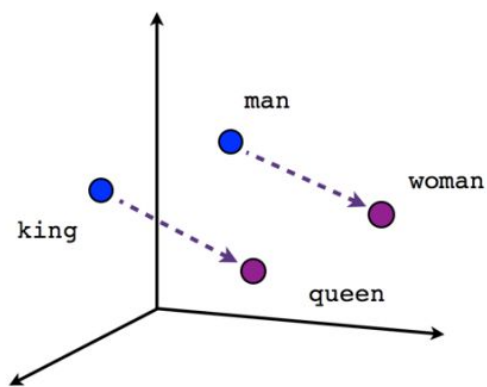

Male-Female

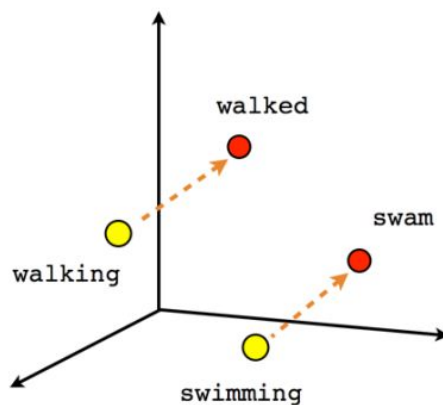

Verb tense

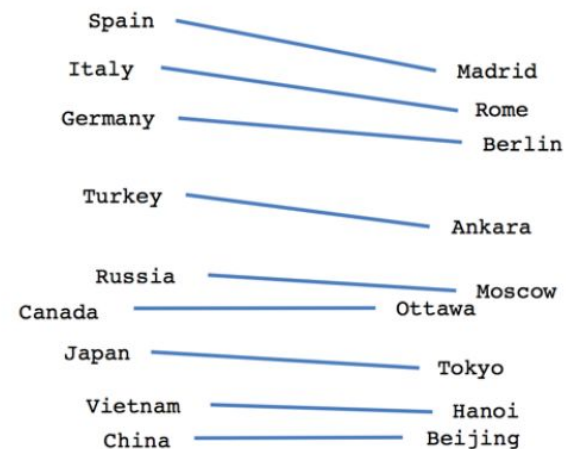

Country-Capital

Examples of Word2Vec

Iraq - Violence = Jordan

Human - Animal = Ethics

President - Power = Prime Minister

Library - Books = Hall

Doc2Vec for classifying paragraphs

Distributed bag of words:

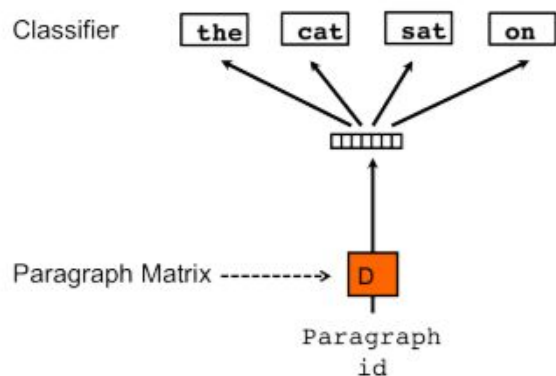

Distributed Memory:

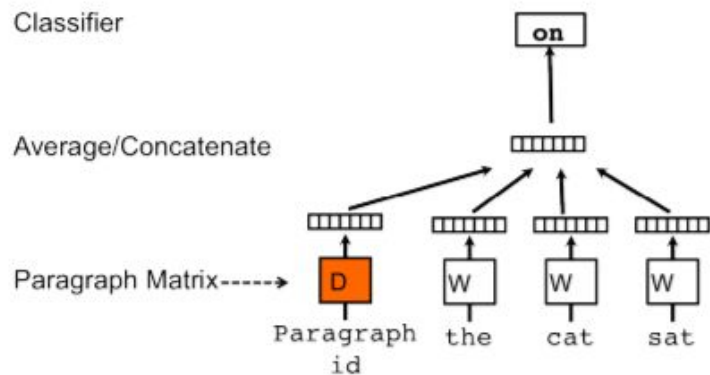

Results

old_content	new_content ▲	pre_context	post_context
me.sendMe...	sendMes...	void perform(){ if (parameters.size() > 0) { ... }	}}}
me.sendMe...	sendMes...	void perform(){ Factions.log("=== RELOAD ... }	}
sendMessa...	sendMes...	boolean onContextItemSelected(android.view....	return true; } return false; }
return;	sendNew...	void maybeSendUOMAnnounce(PeerNode peer)...	} } if ((!dontHaveUpdate) && hasBee...
sendOurRef...	sendOur...	boolean transferNoderef(){ long xferUID = m...	}else { } } catch (FSParseExceptio...
Invocation i...	sendProc...	void sendMigrationComplete(){ for (MemberI...	} }}
sendProgre...	sendPro...	void saveReadingPosition(){ if (this.bookView...	} }}

Eclipse: 59'060 examples

General: 91'644 examples

50% Accuracy => No learning achieved

Conclusion



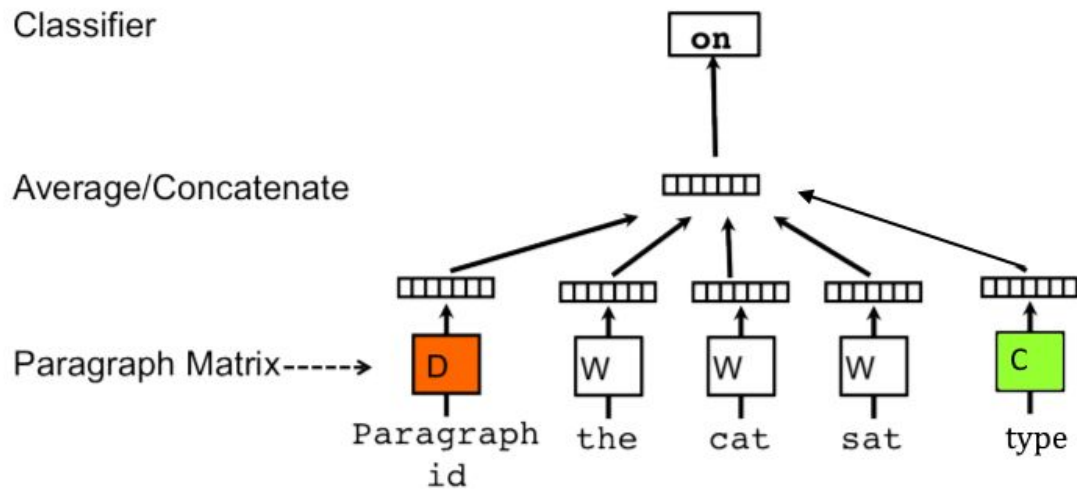

Doc2Vec not fitting for bug prediction

Maybe with modifications?



Different approach - Code Metrics

32 Features of Classes and their number of bugs in 5 projects

	Number of Classes	Buggy Classes
	997	20%
	1'497	14%
	324	40%
	1'862	13%
	692	9%

Neural Nets

Input / Output / Hidden Layers

Difference Deep learning - Neural Nets

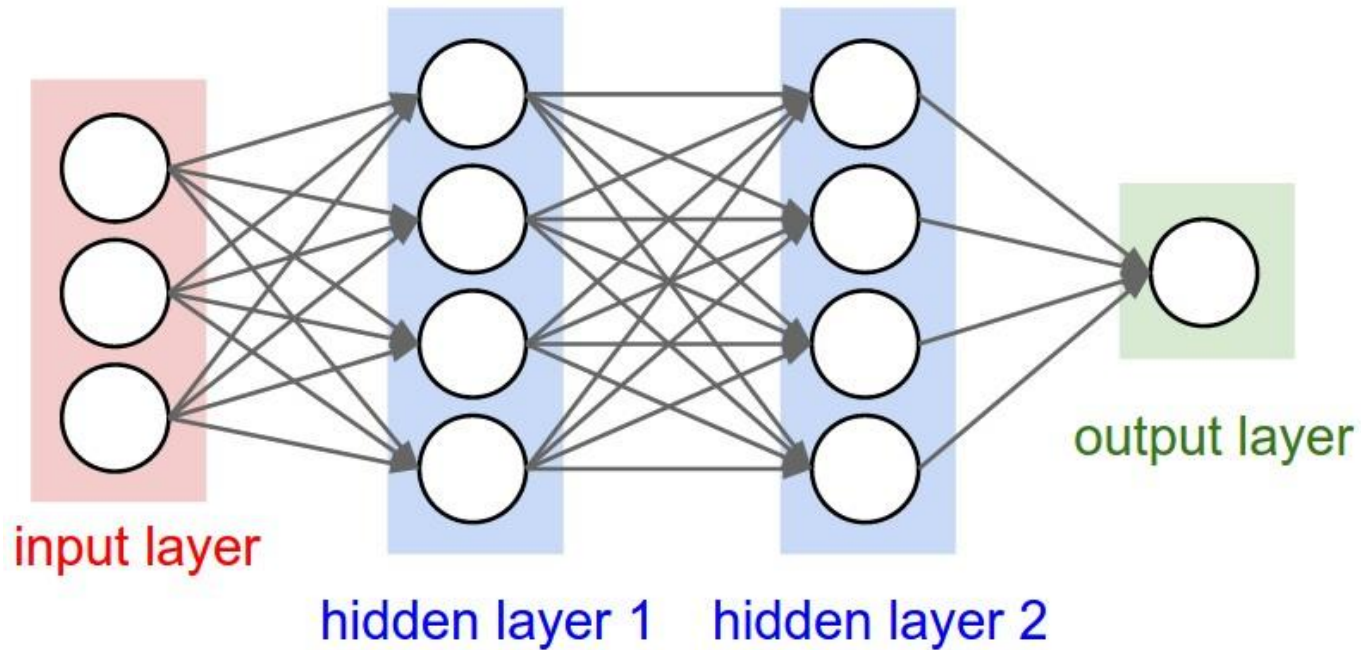

Regression by Classification

Classification with number of bugs as labels

Take the label as value for regression

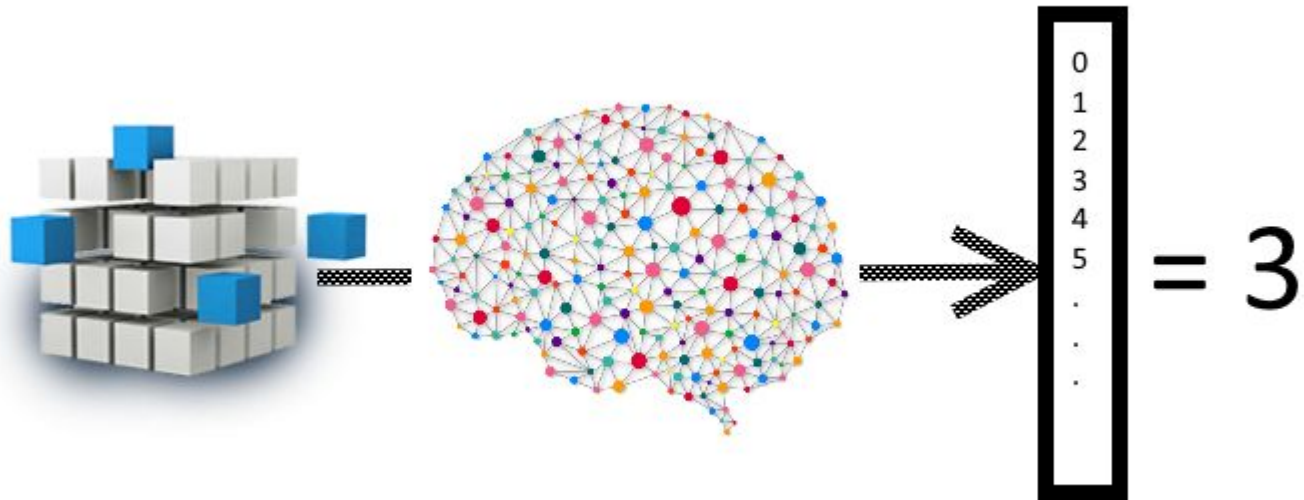

Classification by Regression

Regression on features in respect to bugs

Classified based on RMSE

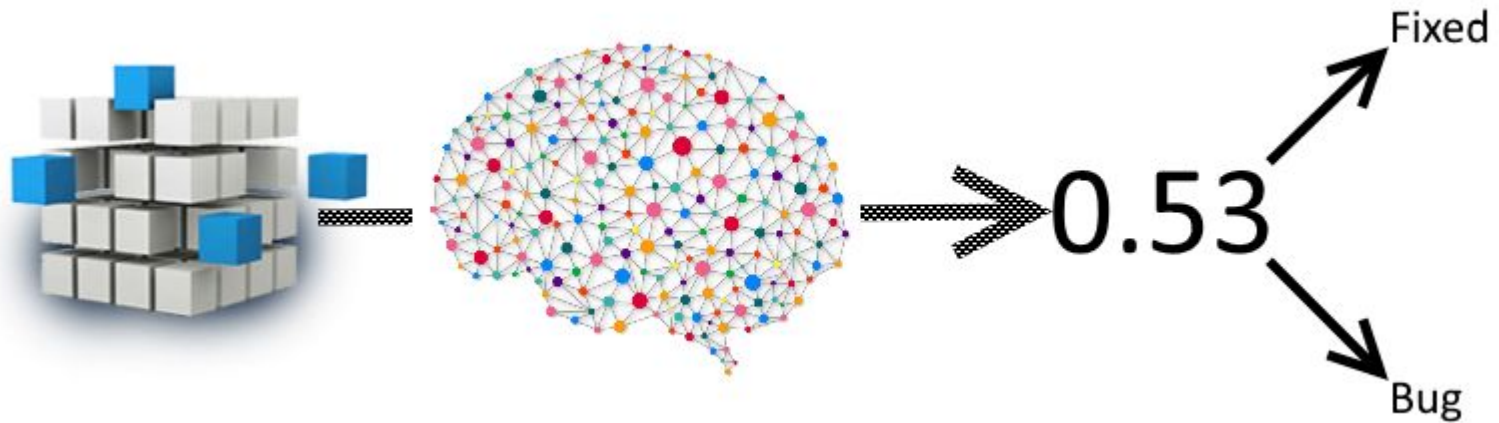

Results

Seems to be working well for code

Improvements had to be made (K-fold Cross-Validation, Oversampling, Stratification)

Classification by Regression:

acc_multi	acc_bin	precision	recall	rmse
0.617101	0.784359	0.766474	0.68359	0.773566

Regression by Classification:

acc_multi	acc_bin	precision	recall	rmse
0.665638	0.76948	0.796334	0.581013	0.91823

Future Work

Extract metrics from plain text

or

Construct AST from plain text and feed it with context knowledge

Questions / Suggestions?